

General description

Symbol	Value
V_{DSS} @ $T_C=25^\circ\text{C}$	Min 650V
I_D @ $T_C=25^\circ\text{C}$	11.2A
$R_{DS(on)}$	Typ 350mΩ
Q_G	Typ 16nC

Features

- Low resistance
- Avalanche rated
- Low package inductance

Applications

- Power factor correction
- Server power supplies
- Telecom power supplies
- Inverters
- Motor control

Maximum ratings ($T_C = 25^\circ\text{C}$)

Parameter	Symbol	Test condition	Value	Unit
Drain - source voltage	V_{DSS}	$T_C=25^\circ\text{C}$	650	V
Gate - source voltage	V_{GS}	-	± 30	V
Continuous drain current	I_D	$V_{GS}=20\text{V}, T_C=25^\circ\text{C}$	11.2	A
		$V_{GS}=20\text{V}, T_C=100^\circ\text{C}$	7.1	A
Pulsed drain current	$I_{D(pulse)}$	Pulse width t_p limited by $T_{j,max}$	44	A
Avalanche energy, single pulse	E_{AS}	$I_D=1.8\text{A}, V_{DD}=50\text{V}$	200	mJ
Avalanche energy, repetitive	E_{AR}	$I_D=1.8\text{A}, V_{DD}=50\text{V}$	0.6	mJ
Avalanche current, repetitive	I_{AR}	-	1.8	A
Power dissipation	P_D	$T_C=25^\circ\text{C}$	95	W
Operating and storage temperature range	T_{j}, T_{stg}	-	-55 to 150	$^\circ\text{C}$

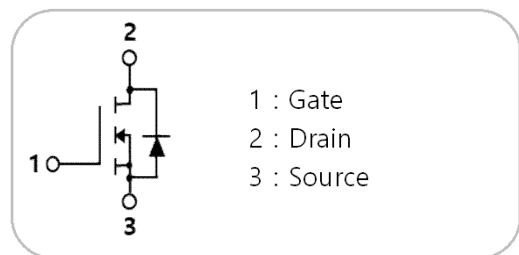
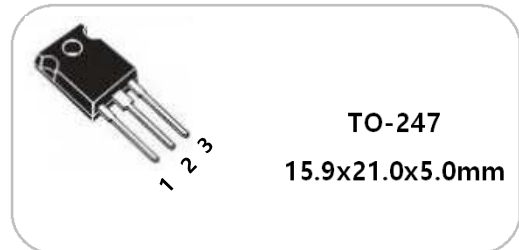
Package



Electrical characteristics ($T_j = 25^\circ\text{C}$)

Parameter	Symbol	Test condition	Value			Unit
			Min	Typ	Max	
Drain-source breakdown voltage	$V_{(BR)DSS}$	$V_{GS}=0V, I_D=1mA$	650	-	-	V
Zero gate voltage drain current	I_{DSS}	$V_{DS}=650V, V_{GS}=0, T_j=25^\circ\text{C}$	-	-	10	μA
		$V_{DS}=650V, V_{GS}=0, T_j=150^\circ\text{C}$	-	-	100	μA
Gate-source leakage current	I_{GSS}	$V_{GS}=20V, V_{DS}=0V$	-	-	200	nA
		$V_{GS}=-20V, V_{DS}=0V$	-	-	200	nA
Gate threshold voltage	$V_{GS(th)}$	$V_{DS}=V_{GS}, I_D=100\mu\text{A}$	2.5	3.5	4.8	V
Drain-source on-state resistance	$R_{DS(on)}$	$V_{GS}=10V, I_D=5.6A$	-	350	380	$\text{m}\Omega$
Gate input resistance	R_G	$f=1\text{MHz}$, open drain	-	1.1	-	Ω
Input capacitance	C_{iss}	$V_{GS}=0V, V_{DS}=100V, f=1\text{MHz}$	-	620	-	pF
Output capacitance	C_{oss}		-	28	-	
Reverse transfer capacitance	C_{rss}		-	5	-	
Effective output capacitance, energy related	$C_{o(er)}$	$V_{GS}=0V, V_{DS}=400V$	-	65	-	pF
Gate-source charge	Q_{GS}	$V_{DS}=480V, V_{GS}=0 \text{ to } 10V, I_D=5.6A$	-	16	-	nC
Gate-drain charge	Q_{GD}		-	5	-	
Total gate charge	Q_G		-	6.5	-	
Turn on delay time	$t_{d(on)}$	$V_{DS}=400V, V_{GS}=10V, I_D=5.6A, R_G=1\Omega$	-	8	-	ns
Rise time	t_r		-	25	-	
Turn off delay time	$t_{d(off)}$		-	25	-	
Fall time	t_f		-	30	-	

Body diode(source – drain) electrical characteristics (T_C = 25°C)

Parameter	Symbol	Test condition	Value			Unit
			Min	Typ	Max	
Forward voltage	V _{SD}	V _{GS} =0V, I _{SD} =11.2A	-	0.85	-	V
Continuous diode Forward current	I _S	V _{GS} =0V, T _C =25°C	-	11.2	-	A
Reverse recovery time	T _{rr}	V _{GS} =0V, I _S =11.2A, di/dt=-100A/μs	-	250	-	ns
Reverse recovery charge	Q _{rr}		-	2.5	-	nC
Peak reverse Recovery current	I _{rrm}		-	16	-	A

Thermal characteristics (T_C = 25°C)

Symbol	Parameter	Typ	Max	Unit
R _{th(j-c)}	Junction to case	1.1	1.3	°C/W

t_p – Z_{th(j-c)} Characteristics

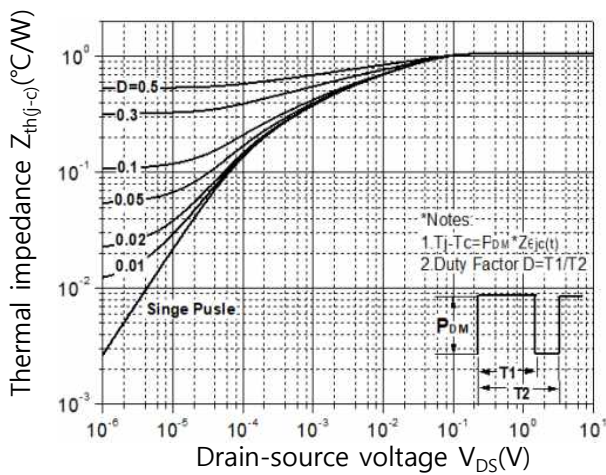

T_C – P_D Characteristics

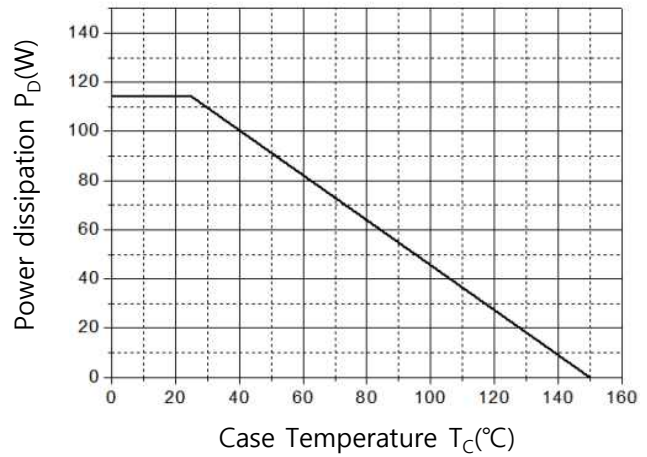

Typical electrical characteristics curves ($T_C = 25^\circ\text{C}$)

$V_{DS} - I_D$ Characteristics, $T_j = 25^\circ\text{C}$

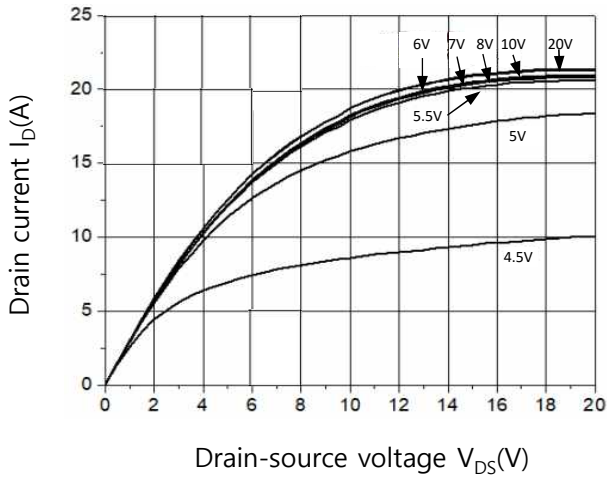

$I_D - R_{DS(on)}$ Characteristics

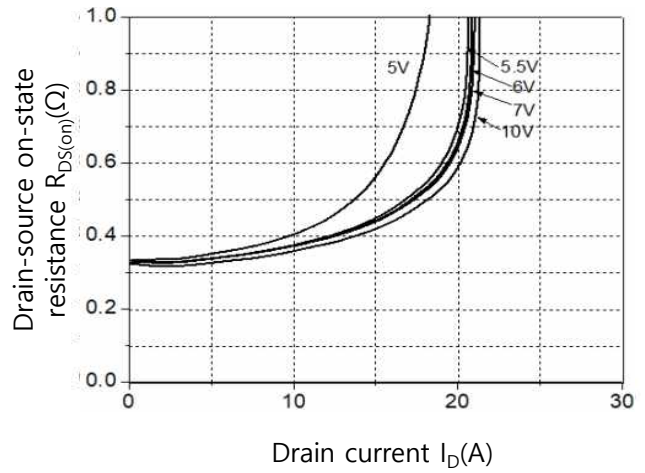

$T_C - R_{DS(on)}$ Characteristics

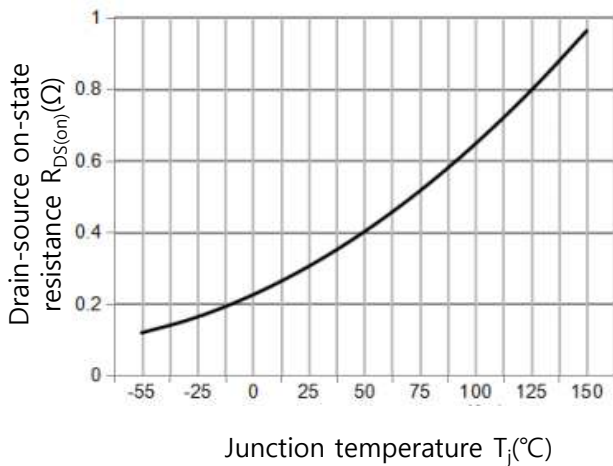

$V_{GS} - I_D$ Characteristics

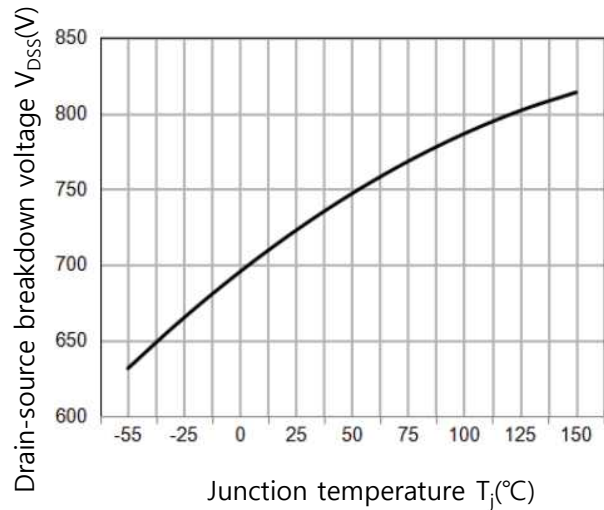

$V_{GS} - I_D$ Characteristics

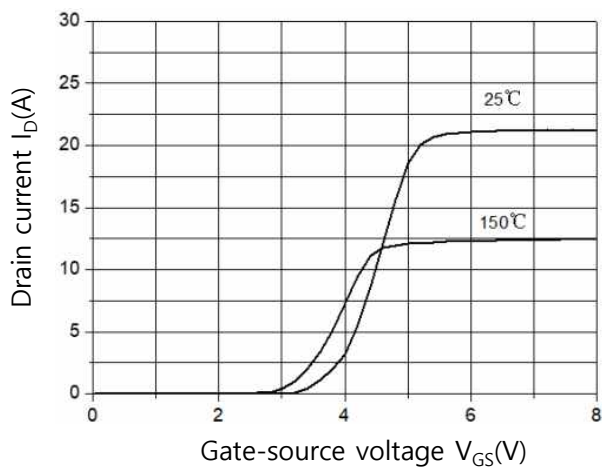

Typical electrical characteristics curves (T_C = 25°C)

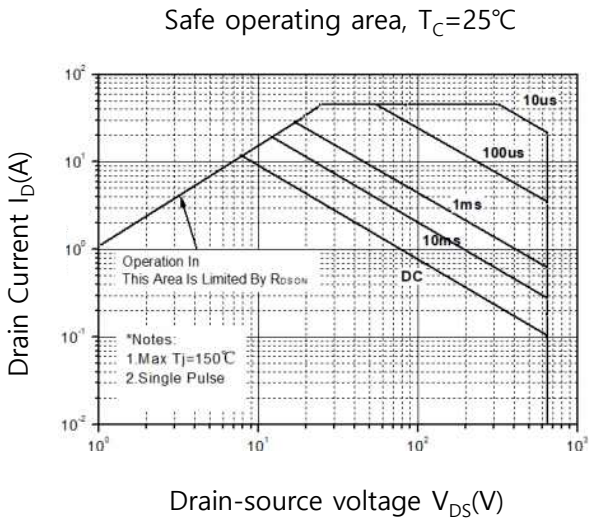
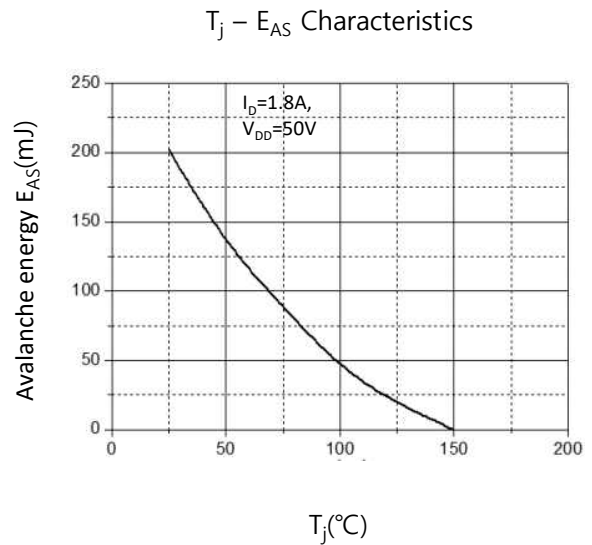
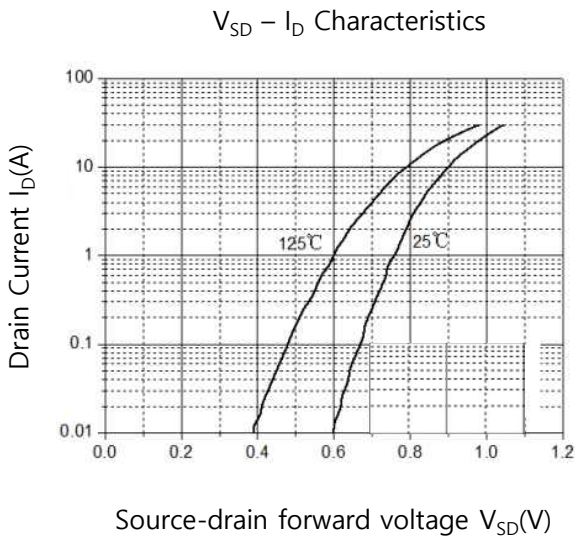
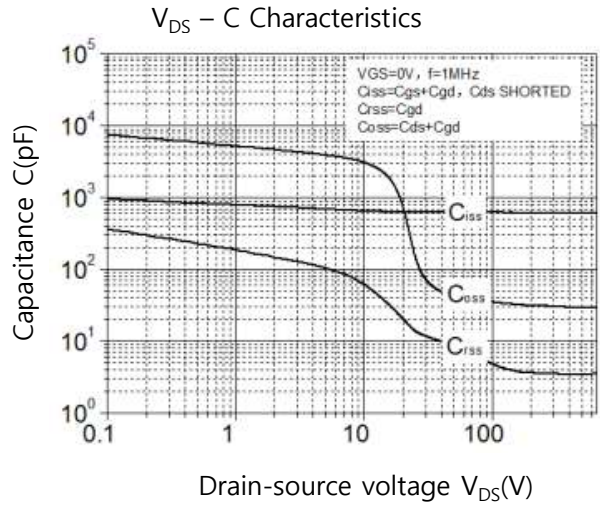
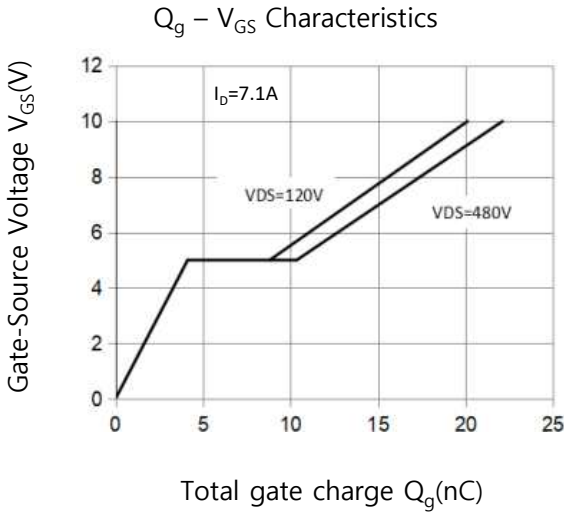

Typical device performance

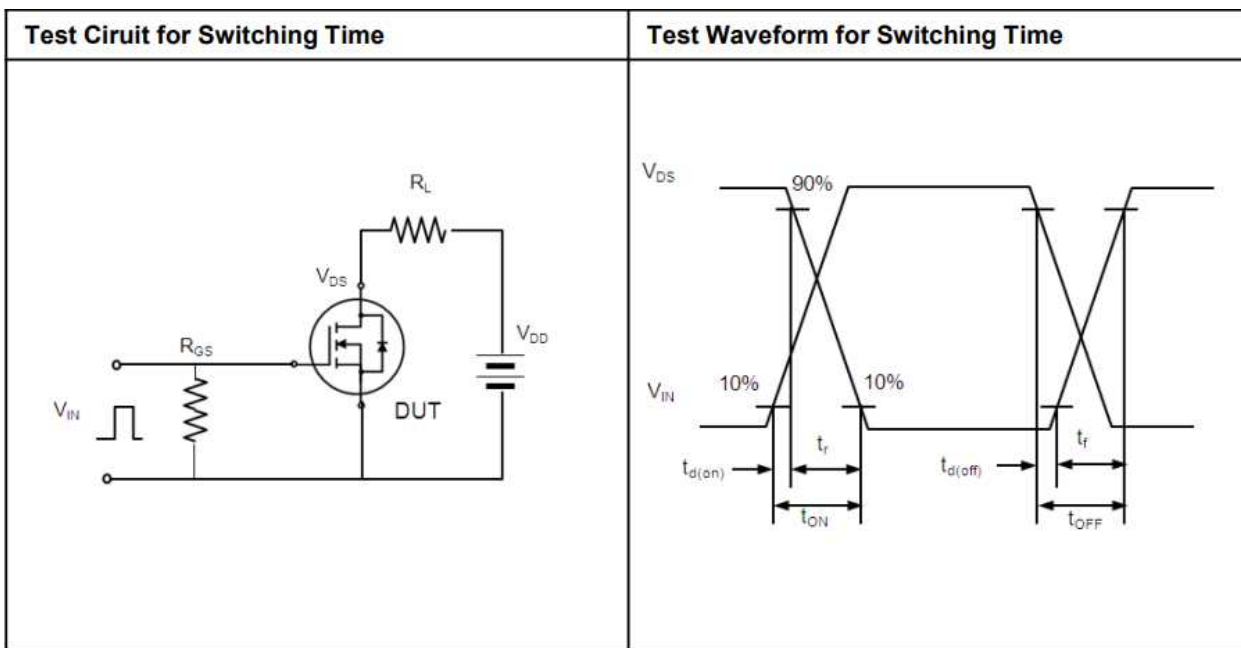
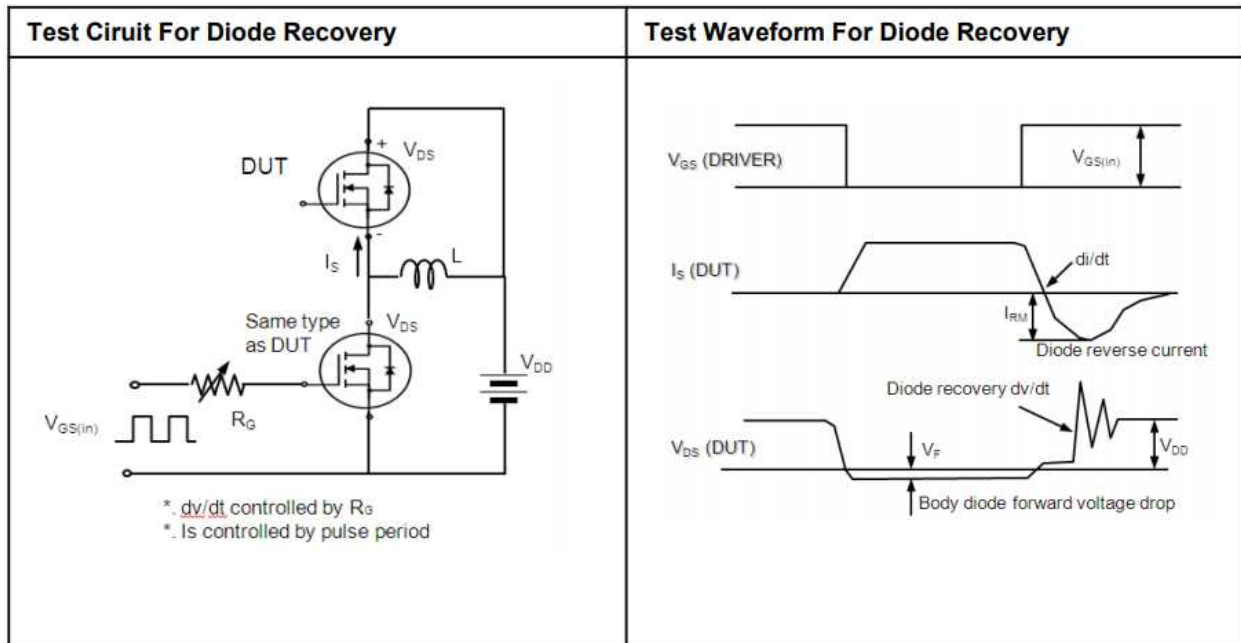

Typical device performance

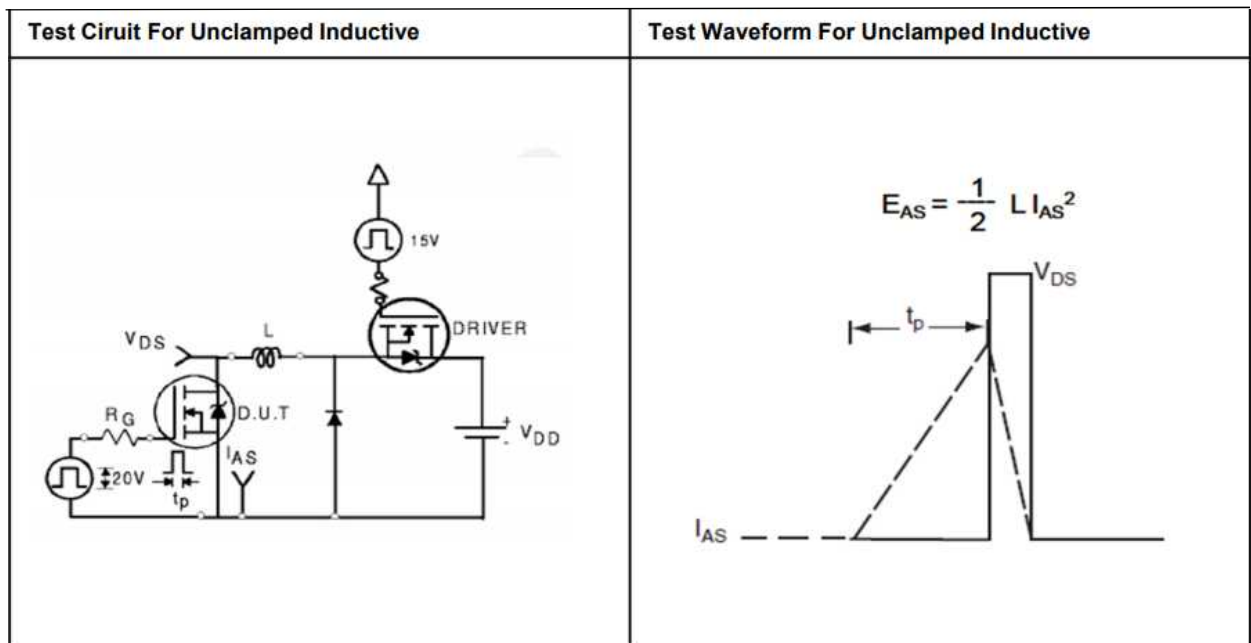
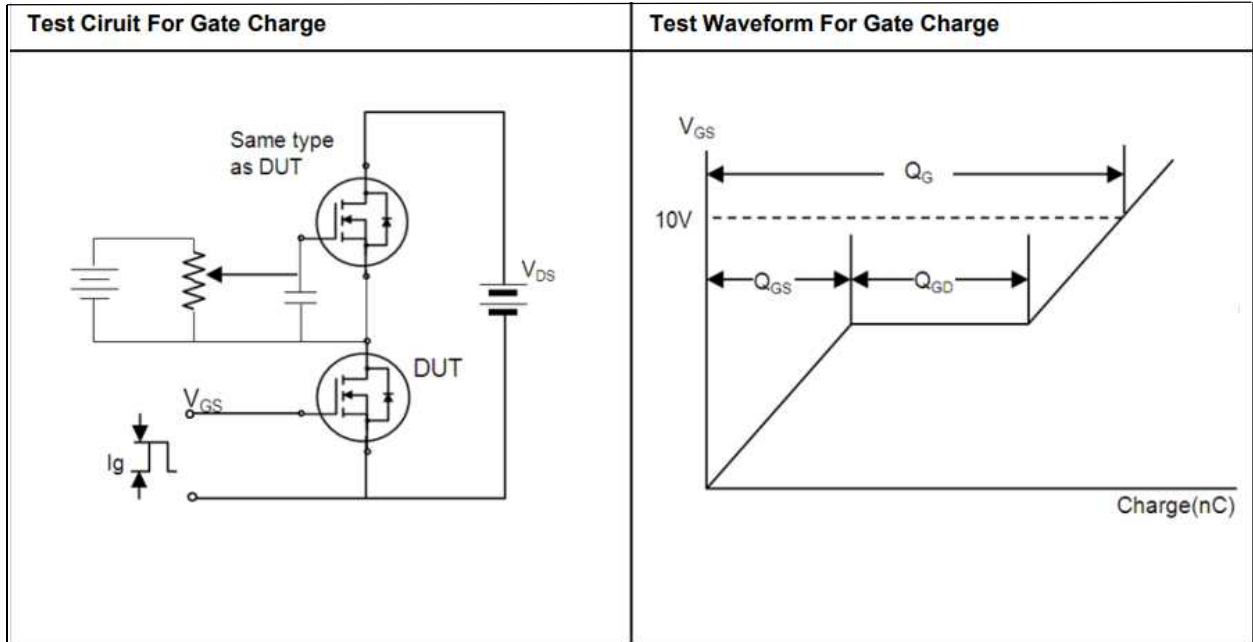

Package dimensions (TO-247)

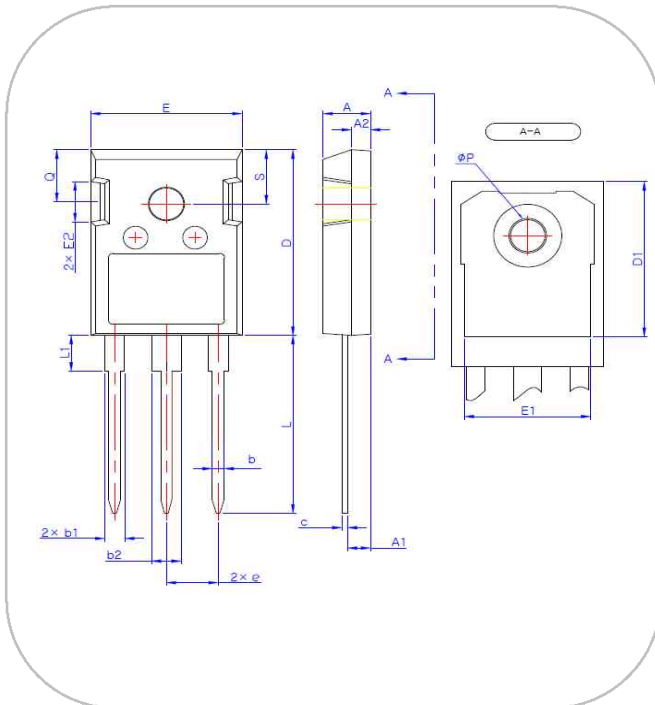

Symbol	Min	Nom	Max
A	4.80	5.00	5.20
A1	2.29	2.36	2.54
A2	1.90	2.00	2.10
b	1.10	1.20	1.30
b1	1.91	2.11	2.20
b2	2.92	3.10	3.20
c	0.50	0.60	0.70
D	20.80	21.07	21.34
D1	17.43	17.63	17.83
E	15.75	15.94	16.13
E1	13.06	13.26	13.46
E2	4.32	4.58	4.83
e	5.45 BSC		
L	19.85	20.00	20.25
L1	-	-	4.49
ΦP	3.55	3.60	3.65
Q	5.59	5.89	6.19
S	6.15 BSC		

Marking information

